

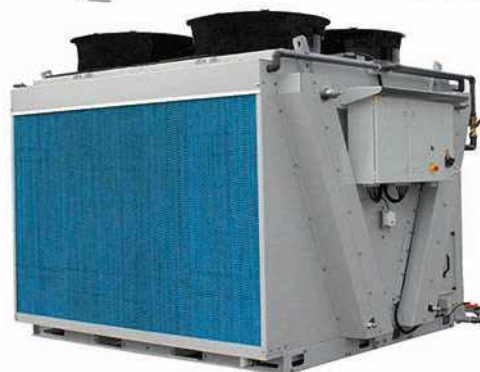

**BALTIMORE
AIRCOIL COMPANY**



TVFC Adiabatic Cooler Once Through Mode

SOFTWARE INSTRUCTIONS

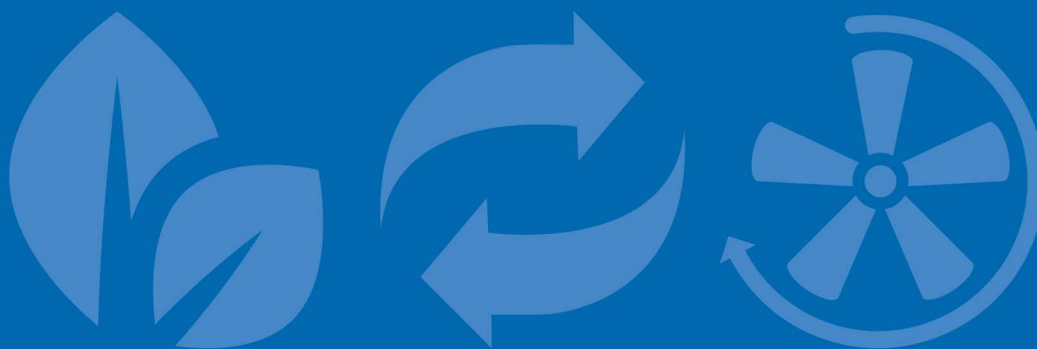



Table of contents

SOFTWARE INSTRUCTIONS

1	Scope	3
	Once Through execution	3
2	Control Logic	4
3	Programmable logic controller	6
	Programmable Logic Controller (PLC)	6
	Display and operations	6
4	Software	8
	Menu overview	8
	Main Loop Menu (P)	9
	User Menu (E)	10
	Working Time Menu (T)	15
	Inputs Outputs Menu (I)	16
	Clock Menu (K)	17
	Logger Menu (H)	17
	System Information (S)	18
	Maintenance Menu (M)	18
5	Alarms and Warnings overview	20
	Alarms overview	20
6	BMS Communication	22
	Available communication protocols and communication cards	22
	Communication table for Bacnet IP	23
	Commissioning guide Bacnet IP	26
7	Further Assistance & Information	32
	More information	32
	The service expert for BAC equipment	32

This manual applies to units configured in Once-Through mode operating on BAC software version V2.0.15 or later, in stand-alone mode.

Once Through execution

The TVFC is a V-shaped dry cooler equipped with **adiabatic pre-coolers (1)** that cool the warm **process fluid (2)** by sensible heat transfer. **Water flows (3)** evenly over evaporative cooling pads located in front of the **dry finned coil (4)**. At the same time **axial (5) fans** draw **air (6)** through the pads where a portion of the water evaporates and cools down the saturated air. This increases the cooling capacity of the incoming air for cooling the process **fluid (7)** inside the coil.

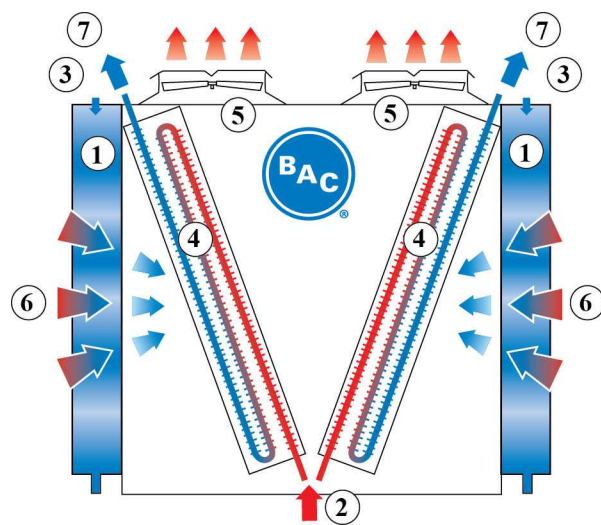

CONTROL LOGIC

The controller controls the fan speed based on the actual fluid outlet temperature and the standard or free-cooling setpoint, ensuring a minimum electrical consumption and noise level. The controller will activate and deactivate the adiabatic pre-coolers, one by one, based on a logical combination of fan speed and two ambient temperature switchpoints.

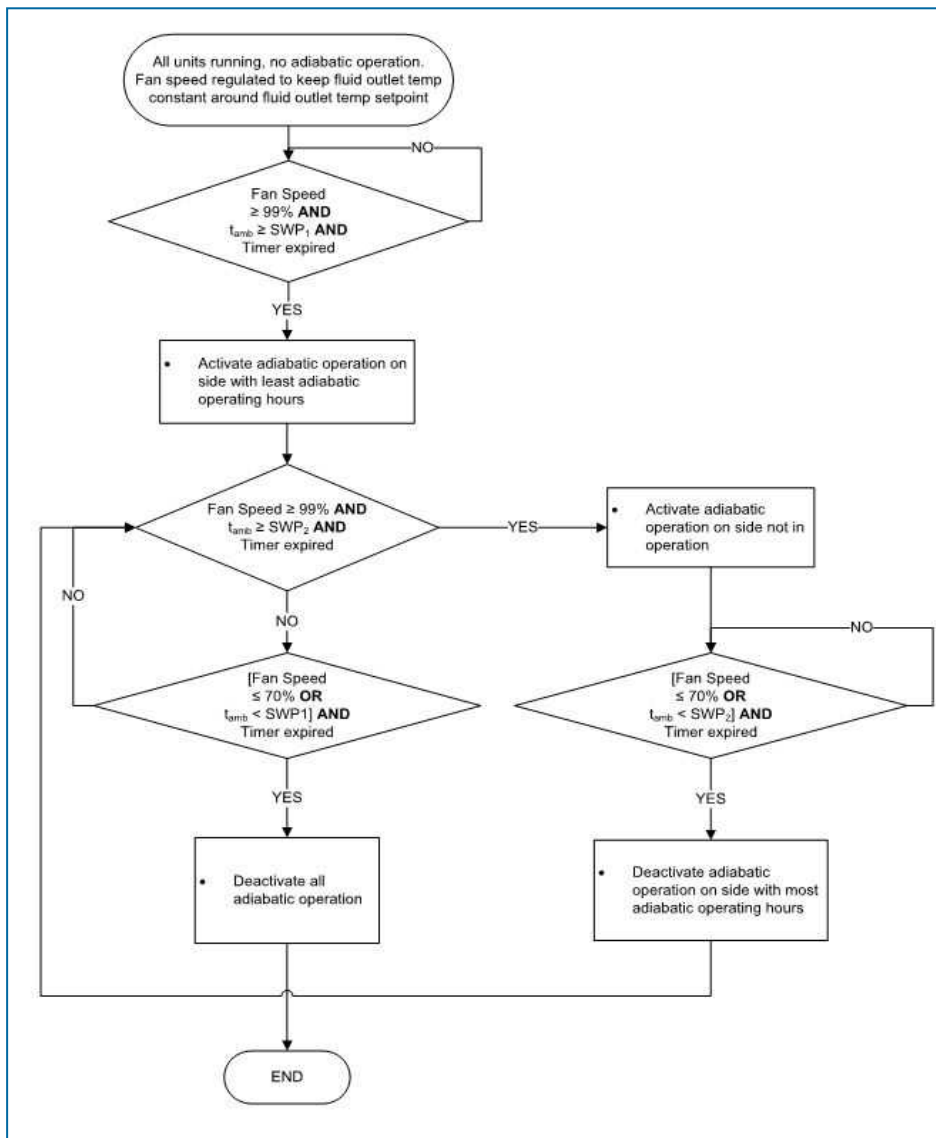

t_{amb} : ambient temperature
 SWP1, SWP2: ambient temperature switchpoints
 CWV: adiabatic pre-cooler city water valve
 DV: adiabatic pre-cooler drain valve

The standard setpoint, the free-cooling setpoint and the two ambient temperature setpoints are adjustable via the User menu. The controller continuously measures the fluid outlet temperature via a temperature sensor installed in the fluid out pipe and the ambient temperature via a temperature sensor that is factory installed on the unit.

The controller is pre-programmed and ready for operation. However, depending on the size of the installation, you may need to adjust the pre-programmed parameters during start-up.



CAUTION

Changing the controller's parameters may result in an undesired operation of the unit such as a hunting phenomenon, premature activation of pre-cooling (hence increased water consumption) or in late pre-cooling activation resulting in fluid outlet temperatures exceeding the design temperature.

Programmable Logic Controller (PLC)

The PLC with built-in display:







Display and operations

The controller display contains the screen and six operation keys.

The screen allows eight lines of text. The screen title and the screen reference are always on the top line.

Use the operation keys to navigate between the different menus and screens.

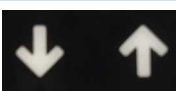
	Alarm key	Display the alarm menu.
	Menu key	Display the main menu screen.

 A black square icon containing a white curved arrow pointing to the left, representing a back key.	Back key	Revert to the previous step or menu.
 A black square icon containing two white arrows: one pointing down and one pointing up, representing arrow keys.	Arrow keys	Navigate between the different screens and menus.
 A black square icon containing a white L-shaped arrow pointing left and down, representing an enter key.	Enter key	Select the marked menu or parameter or enable the change of a parameter.



Menu overview

Menu	Screen reference	Function
Main loop	P	Readout: <ul style="list-style-type: none">- The unit status (ON/OFF)- The fluid outlet and ambient temperature- The fan speed- The pre-cooler status
User	E	Set: <ul style="list-style-type: none">- Run authorisation / local ON/OFF- Standard and free-cooling set-point- PI parameters- Ambient temperature switch point for Adiabatic pre-cooling- Adiabatic pre-cooler delay- Adiabatic pre-cooler cleaning cycle- Night quiet mode- Time delay on alarm messages- BMS communication settings The standard password for the User Menu is "1234".
Manufacturer	C	This menu is password protected and is not accessible to unauthorized personnel.
Working time	T	Readout the operating hours for the fans and adiabatic pre-cooling.
Inputs/outputs:	I	Readout the input and output status.
Clock	K	Set the correct time and date.
Logger	H	Readout the alarm and warning history.
System info	S	Readout the software and bios version.
Maintenance	M	Set the inputs and outputs manually for test purposes. The standard password for the Maintenance menu is "9876".

Main Loop Menu (P)



The screens in the Main Loop Menu are read-only and cannot be edited.

Screen P01

```

10:50 23/11/18 P01
BACH1800000 01 Ad:1
Setpoint 06.0bar
Pout 03.1bar
Tamb 33.1°C
Fan speed 000.0%
On
  
```

Main screen with general information:

- The current time and date.
- The unit serial number and pLAN address: “**Ad: 0**”.
- “**Setpoint**”: the active setpoint for the condenser pressure.
- “**Pout**”: the measured condenser pressure.
- “**Tamb**”: the measured ambient temperature.
- “**Fan speed**”: the current fan speed.
- The unit status: “**ON**” or “**OFF**”.

Note

Unit status ON implies that the unit is ready to automatically respond to any heat rejection requirement, even in case the fans are temporarily deactivated due to the absence of a heat load.

Screen P03

```

Inputs P03
Pout 003.1bar
Tamb 033.1°C
Control signal 000.0%
Local En/Dis ON
BUS En/Dis ON
  
```

Overview of all inputs:

- “**Pout**”: the measured condenser pressure.
- “**Tamb**”: the measured ambient temperature.
- “**Control signal**”: the calculated fan speed reference.
- “**Local En/Dis**”: the status of the remote start/stop (dry contact between terminals Y4:1-Y4:4).
- “**BUS En/Dis**”: the status of the BMS controlled variable “**Run authorization**” (refer to screen E02).

Screen P04

```

Pre-cooling P04
Pre-cooler A OFF
Pre-cooler B OFF
  
```

Adiabatic pre-cooling status:

- “**Pre-cooler A**”: shows the status of the adiabatic pre-cooler on side A.
- “**Pre-cooler B**”: shows the status of the adiabatic pre-cooler on side B.

Screen P05

```

Pre-cooling P05
Program state
0: Dry op./Wait AD op.
Tpc 00000 ---
Tcww 00000 ---
Td 00000 ---
Tp 00000 ---
Deconc. counter 00
  
```

Adiabatic pre-cooling status: readout the status of the different timers and the deconcentration counter:

- “**Tpc**”: pre-cooling timer, delays the activation and deactivation of the adiabatic pre-cooling.
- “**Tcww**”: city water valve timer: extends the city water supply after the pump has started.
- “**Td**”: drain valve timer, delays emptying of the sump.
- “**Tp**”: pump timer, protects the pump against running dry.
- “**Deconc. Counter**”: counts the number of sump refills.

Screen P10-P51

```

ecmPn_EBM_fan_HV2_P10
Offline Addr:002
Current speed 0000rpm
Max speed 00000 rpm
Power 00000W
Current 00000 mA
  
```

EC fan information screens:

- The fan status: “**Online**” or “**Offline**” and fan address: “**Addr: 002**”.
- “**Current speed**”: the actual fan speed.
- “**Max speed**”: the maximum allowable fan speed.
- “**Power**”: the actual power of the EC fan.
- “**Current**”: the actual current of the EC fan.

Note

In case an EC fan shows the status “Offline”, check the power supply to the fan and the Modbus communication wiring to the fan.

User Menu (E)



The screens in the User Menu are editable. The standard password is “1234”.

Screen E01

```

Language E01
Language
French
Site name
BACH1607697 01
  
```

- “**Language**”: set the controller language to English, French, Dutch, Spanish or German.
- “**Site name**”: enter the unit serial number or the site name.

Screen E02

```

Setpoints E02
Run authorisation ON
Setpoints
Standard 06.0bar
Free cooling 05.0bar
  
```

- “**Run authorization**”: activate or deactivate the unit. This variable can either be set directly in this screen or via a BMS variable (see section 6: BMS communication).
- “**Standard setpoint**”: the default setpoint for the condenser pressure.

- **“Free cooling setpoint”**: the setpoint for the condenser pressure when the unit operates in free cooling mode. Switch over to free cooling mode via a BMS controlled variable or via the dry contact between terminals Y4:2-Y4:4.

Example

*The controller controls the fan speed based on the actual condenser pressure and the standard setpoint when the dry contact between terminals Y4:1-Y4:4 is open.
When the dry contact between terminals Y4:1-Y4:4 is closed, the controller controls the fan speed based on the actual condenser pressure and the free cooling setpoint.*

Screen E03



PI-parameters: these parameters determine the unit’s reaction speed to changes in fluid outlet temperature.

- **“Prop. Band”**: set the value for the proportional band of the PI controller.
- **“Integr. Time”**: set the value for the integration time of the PI controller.



CAUTION

Changing the PI-Parameters may result in a hunting phenomenon.

Note

Make the unit react faster to changes in fluid outlet temperature by decreasing the proportional band and the integration time, or make the unit react slower by increasing the proportional band and integration time.

Screen E04

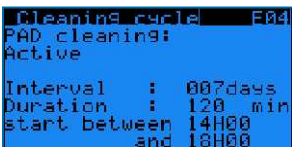

Cleaning cycle for the adiabatic pre-coolers:

- **“PAD cleaning”**: allows you to enable or disable the cleaning cycle function.
- **“Interval”**: set the period (the number of days the adiabatic pre-cooling has not functioned) after which the cleaning cycle must activate.
- **“Duration”**: set the duration for the pre-cooler cleaning cycle.
- Set the time interval for the start of the cleaning cycle.

Example

The pre-cooler cleaning cycle activates the pre-coolers during 120 minutes when the unit has not operated adiabatically for a period of 7 days. The cleaning cycle starts between 14h00 and 18h00.

Note

The controller automatically disables the cleaning cycle when the ambient temperature is below 4°C.

Screens E05-E06

AD switchpoints E05		Pre-cooler delay E06	
Switchent.1	25.0°C	AD ON delay	0030s
Switchent.2	28.0°C	AD OFF delay	0030s
AD ON fan speed	099%		
AD OFF fan speed	070%		

Adiabatic pre-cooler temperature and fan speed switchpoints and time delays:

- “**AD switchpnt.1**” and “**AD switchpnt.2**”: the temperature switchpoints for the activation of the adiabatic pre-coolers.
- “**AD ON fan speed**” and “**AD OFF fan speed**”: the fan speed switchpoints for the activation and deactivation of the adiabatic pre-coolers.
- “**AD ON delay**” and “**AD OFF delay**”: the time delays for the activation and deactivation of the adiabatic pre-coolers.

Example

- The first pre-cooler will activate when the ambient temperature > 25.0°C **AND** the fan speed > 99%, after a 300 seconds delay.
- The second pre-cooler will activate when the ambient temperature > 28.0°C **AND** the fan speed > 99% after a 300 seconds delay.
- The first pre-cooler will deactivate when the ambient temperature < 27.9°C **OR** the fan speed < 70% after a 30 seconds delay.
- The second pre-cooler will deactivate when the ambient temperature > 24.9°C **OR** the fan speed < 70% after a 30 seconds delay.

Note

The temperature and fan speed switchpoints determine the operating strategy of the unit. High temperature switchpoints combined with high fan speed switchpoints typically result in high water savings on the adiabatic pre-cooling, while lower temperature and fan speed switchpoints typically result in higher electrical energy savings on the EC fans.

Screens E10-E11-E12

Night Quiet mode E10	DAYTIME E11	Night Quiet mode E12
Night Quiet Mode OFF	MON from00H00 to00H00 TUE from00H00 to00H00 WED from00H00 to00H00 THU from00H00 to00H00 FRI from00H00 to00H00 SAT from00H00 to00H00 SUN from00H00 to00H00	AD switchpoints in night quiet mode Switchent.1 15.0°C Switchent.2 18.0°C
Daytime s.limit 100.0% Night s.limit 000.0%		
Control: Clock		

Night quiet mode: predefine fan speed limits for both day and night time.

- Enable/Disable the Night quiet mode and choose the maximum allowed fan speed during day and night on screen E10:
 - “**Night quiet mode**”: “**ON**” or “**OFF**”: enable or disable the Night quiet mode.
 - “**Daytime speed limit**” and “**Night time speed limit**”: set the maximum allowed fan speed during day and night time.
 - “**Control**”: choose the activation mode: either via a BMS controlled variable (“**via BMS**”) or via a predefined time daytime schedule in screen E11 (“**Clock**”).
 - “**Daytime clock**” Set up a time schedule for the daytime speed limit in screen E11: Monday to Sunday, start time to end time.



Outside of this time schedule, the night time speed limit will apply.

- “**Via BMS**”: Use parameter “**Night quiet mode day/night time speed limit via BMS**” to switch between daytime speed limit and night time speed limit (Refer to the communication tables in Chapter 6).
- Set specific adiabatic pre-cooler switchpoints for Night quiet mode operation in screen E12:
 - “**AD switchpnt.1**” and “**AD switchpnt.2**”: specific temperature switchpoints for the activation of the adiabatic pre-coolers when the night time speed limit is active.

Example

The Night quiet mode is enabled, with a daytime speed limit of 80% and a night time speed limit of 50%.

During daytime:

- The first pre-cooler will activate when the ambient temperature > 25.0°C **AND** the fan speed > 79.2% (= 99% x 80%) after a 300 second delay.
- The second pre-cooler will activate when the ambient temperature > 28.0°C **AND** the fan speed > 79.2% after a 300 second delay.
- The first pre-cooler will deactivate when the ambient temperature < 27.9°C **OR** the fan speed < 56% (= 70% x 80%) after a 30 second delay.
- The second pre-cooler will deactivate when the ambient temperature > 24.9°C **OR** the fan speed < 56% after a 30 second delay.

During night time:

- The first pre-cooler will activate when the ambient temperature > 15.0°C **AND** the fan speed > 49.5% (= 99% x 50%) after a 300 second delay.
- The second pre-cooler will activate when the ambient temperature > 18.0°C **AND** the fan speed > 49.5% (= 70% x 80%) after a 300 second delay.
- The first pre-cooler will deactivate when the ambient temperature < 17.9 °C **OR** the fan speed < 35% (= 70% x 50%) after a 30 second delay.
- The second pre-cooler will deactivate when the ambient temperature < 14.9°C **OR** the fan speed < 35% after a 30 second delay.

Screen E14



Adiabatic pre-cooling deactivation function:

- “**Pre-cooler deact.**”: enable or disable the pre-cooler deactivation function.
- Set the period and the time frame during which the unit deactivates the adiabatic pre-cooling.

Example

When the pre-cooling deactivation function is active, the adiabatic pre-cooling cannot activate between 13:00 and 15:00 o'clock from 15/07 to 15/09.

Screen E15



The forced adiabatic operation function allows the unit to activate both pre-coolers simultaneously when the ambient temperature exceeds the fluid outlet setpoint.

Screen E16

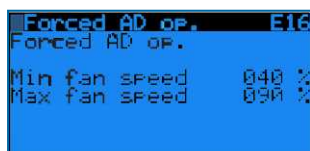

- “**Forced AD op. mode authorization**”: enable or disable the forced adiabatic operation function.
- “**Setp. hyst.**”: hysteresis on the fluid outlet temperature setpoint.
- “**AD act. Delay**”: time delay for the activation of the forced adiabatic operation mode.
- “**Ma/SI unit delay**”: time delay for the activation and deactivation of the pre-cooling in forced adiabatic operation mode.

- **“Min fan speed”**: fan speed switchpoint for deactivation of the pre-cooling in the forced adiabatic operation mode.
- **“Max fan speed”**: fan speed switchpoint for activation of the pre-cooling in the forced adiabatic operation mode.

Example

The forced adiabatic mode activates when $T_{amb} > (\text{“setpoint”} + \text{“setp. hyst.”}) > (30^{\circ}\text{C} + 0^{\circ}\text{C}) > 30^{\circ}\text{C}$ during 1 minute.

While in forced adiabatic mode, the pre-cooling activates and deactivates as follows:

- When the fans operate between 90% (**“Max fan speed”**) and 99%, the pre-cooling activates after 60 s (**“Ma/SI unit delay”**).
- When the fans operate at full speed (100%), the pre-cooling activates after 5 s.
- When the fans operate between 30% and 40% (**“Min fan speed”**), the pre-cooling deactivates after 60 s (**“Ma/SI unit delay”**).
- When the fans stop running, the pre-cooling deactivates immediately.

Screen E17



Choose the communication protocol: Modbus RS485, Modbus IP, Carel RS485, LON, BacNet IP or BacNet MSTP. Set the communication speed and network address, when applicable. See section 6: BMS communication.

Screen E18

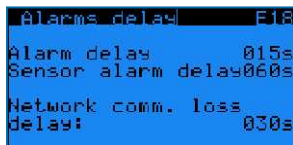

Alarm detection delays:

- **“Alarm delay”**: time delay for EC fan alarms and warnings.
- **“Sensor alarm delay”**: time delay for alarms from the fluid outlet temperature and ambient temperature sensor.
- **“Network comm. Loss delay”**: time delay for the loss of pLAN communication between units (not applicable for stand-alone operation).

Note

The network communication loss delay is not applicable to stand alone operation.

Screens E19-E20

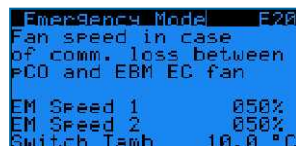
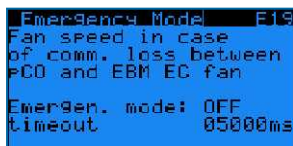

EC fan emergency mode management:

Enable the EC fan emergency mode to select a fixed fan speed for when the Modbus communication between the controller and the EC fans fails.

In case the EC fan emergency mode is disabled, the fans will continue to operate at the latest known fan speed when the Modbus communication between the controller and the EC fans fails.

- **“Emergen. mode”**: “ON” or “OFF”: enable or disable the EC fan emergency mode.
- **“Timeout”**: time delay before the EC fan emergency mode activates.
- **“EM speed 1”**: the emergency speed reference in case the ambient temperature \geq the ambient temperature switchpoint.

- “**EM speed 2**”: the emergency speed reference in case the ambient temperature < the ambient temperature switchpoint.
- “**Switch Tamb**”: the ambient temperature switchpoint.

Example | When the EC fan emergency mode is enabled, EM speed 1 is set to 100%, EM speed 2 is set to 50% and Switch Tamb is set to 15°C, the EC fans will start running at a fixed speed of 100% in case the Modbus communication between the controller and the EC fans fails when the ambient temperature is 20°C.
 In case, the Modbus communication between the controller and the EC fans fails when the ambient temperature is 10°C, the EC fans will start running at a fixed speed of 50%.

Screen E21

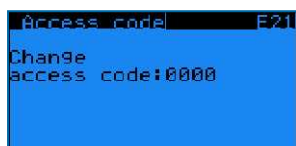

Set your own access code for the User Menu.

Working Time Menu (T)



The screens in the Working Time Menu are read only and cannot be edited.

Screen T02



Read the operating time for the EC fans and for both adiabatic pre-coolers, displayed in hours.

Screen T03

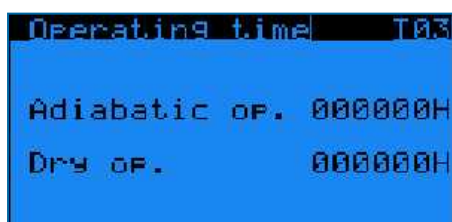

Read the operating time for the EC fans, both adiabatic pre-coolers, and the dry and adiabatic operating time displayed in hours.

Inputs Outputs Menu (I)



The screens in the Inputs/Outputs Menu are read only and cannot be edited.

Screens I01-I02

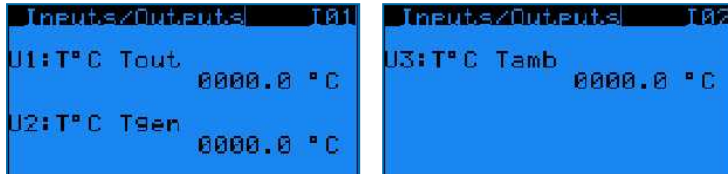

Read the analog inputs on the controller:

- “**U1: Tout**”: the current condenser pressure.
- “**U2: T°C Tgen**”: not used.
- “**U3: T°C Tamb**”: the current ambient temperature.

Screen I03



Read the status of the digital inputs on the controller (open/closed):

- “**ID4-DI: Inverter AI**”: VFD status (not used in case of unit working with EC fans).
- “**ID5-DI: Free cooling**”: status of the free cooling mode (dry contact between terminals Y4:2-Y4:4).
- “**ID1: On-Off**”: status of the remote start/stop command (dry contact between terminals Y4:1-Y4:4).
- “**U5: Fan AI**”: not used.

Screen I04



Read the status of the digital outputs on the controller (open/closed).

- “**NO8: Alarm(s)**”: closed contact means that there are one or more alarms active.
- “**NO7: Warning(s)**”: a closed contact means that there are one or more warnings active.
- “**NO3: RH Pre-cooler**”: a closed contact means that the right pre-cooler is active.
- “**NO2: LH Pre-cooler**”: a closed contact means that the left pre-cooler is active.
- “**NO5: ---**”: not used.
- “**NO6: Operational**”: run indication, a closed contact means that the fans are running.

Screen I05



Read the analog outputs on the controller:

- “**Y3: N.U**”: not used.
- “**Y4: Fan speed**”: a 0-10 Volt control signal, which corresponds to the actual fan speed. (0 V = 0%, 10 V = 100%)

Clock Menu (K)



The screen in the Clock Menu is editable.

Screen K01



Set the correct time and date. Time format: HH:MM:SS and date format: DD/MM/YY.

The software automatically adjusts to Daylight Saving Time.

Logger Menu (H)



The screens in the Logger Menu are read only and cannot be edited.

Screen H01



Read the history of past alarms.

The log shows the alarm message and the time the alarm occurred.

System Information (S)



The screens in System Information are read only and cannot be edited.

Screen S01

Baltimore Aircoil Company		S01
SW Ver.:	1.5.735	
OS Ver.:	4.1.005	
BOOT Ver.:	4.1.005	

"SW Ver.": Current software version installed

"OS Ver.": Operating system version

"BOOT Ver.": Current boot version

Maintenance Menu (M)

Screen M01

MAINTENANCE		M01
Sensor offset		
Outlet (U1)	000.0 °C	
Corr.:	000.0 °C	
General (U2)	000.0 °C	
Corr.:	000.0 °C	
Tamb (U3)	0000.0 °C	
Corr.:	000.0 °C	

Program a sensor offset ("Corr. :") to correct the readings for the condenser pressure sensor ("Outlet (U1)") and the ambient temperature sensor ("Tamb (U3)").

The general outlet pressure sensor is not used in stand-alone operation.

Screen M02

MAINTENANCE		M02
Test mode:	OFF	
Duration:	015min	

Activate the test mode, which allows to manually set analog and digital outputs and control the EC fans.

- "Test mode": activate or deactivate the test mode.
- "Duration": time delay after which the test mode automatically deactivates.

Note

1. Duration set to 99 min keeps the test mode ON indefinitely
2. When the test mode is set to OFF, screens M03 to M07 are invisible.

Screen M03

```

Digital override M03
Pre-cooler R (N03): 
Pre-cooler L (N02): 
Run indicat. (N06): 
Alarm (N08): 
Warning (N07): 
: Open / : Closed
  
```

Manually set the digital outputs:

- “**Pre-cooler R**”: activate or deactivate the right hand pre-cooler.
- “**Pre-cooler L**”: activate or deactivate the left hand pre-cooler.
- “**Run indicat.**”: simulate the run indication.
- “**Alarm**”: simulate an alarm.
- “**Warning**”: simulate a warning.

Screen M05

```

Test mode M05
Output override
analog:
Y3:000.0 Volt
Y4:000.0 Volt
  
```

Manually set the analog outputs:

- “**Y3**”: not used for a unit with EC fan motors.
- “**Y4**”: simulate a 0-10 Volt output.

Screen M06

```

Global fan test M06
Fan speed 000.0%
Control type Global
  
```

Manually control the EC fans:

- “**Fan speed**”: 0% to 100%
- “**Control type**”: choose “**Global**” to operate all fans simultaneously at the same speed or choose “**1 by 1**” to set the speed for each fan individually via screen M07.

Screen M07

```

Test indiv. fans M07
N° 2 000.0% N° 9 000.0%
N° 3 000.0% N° 10 000.0%
N° 4 000.0% N° 11 000.0%
N° 5 000.0% N° 12 000.0%
N° 6 000.0% N° 13 000.0%
N° 7 000.0% N° 14 000.0%
N° 8 000.0% N° 15 000.0%
  
```

Set the speed for each fan individually.

Alarms overview

- Access the alarms by pressing the alarm button on the controller (triangle with exclamation mark).
- If a particular alarm is no longer present, the alarm message is automatically cleared and the general alarm (NO1) deactivates.
- To see the history of past alarms, check the logger menu.

Note | *The Alarm status can be read out via dry contact on terminal Y3: 3/4/5 and the warning status on Y3: 1/2 in the control panel.*

Screen AL000

No alarm present.

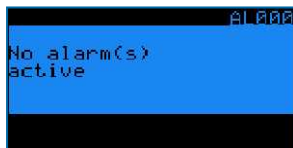

Screen AL001



Fluid outlet temperature sensor (on input U1) is defective.

- Unit stops working.
- Alarm message AL001 on controller display + general alarm (NO1) activates.

Screen AL003



Ambient air temperature sensor (on input U3) is defective.

- Unit remains operational in dry mode, adiabatic operation no longer possible.
- Alarm message AL003 on controller display + general alarm (NO1) activates.

Screens AL010-AL106



Alarms and warnings from the EC fans. Consult BAC factory for more information.

- Unit remains operational, but the defective fan stops working.





6 BMS COMMUNICATION





Available communication protocols and communication cards

The following communication protocols are available: Carel RS485, Modbus RS485, Modbus TCP/IP, Bacnet IP, Bacnet MS/TP and LON. The table below shows the required communication card and software settings for each communication protocol.



Based on your selection, this manual will only contain the information you require.

Protocol	Communication card reference	Typical parameter settings in the controller	Interface file required?	Available settings
CAREL RS485		<pre>Supervision E17 BMS communication CAREL RS485 Baud rate 19200 Address 001</pre>	No	- Baudrate: 1200 to 19200 - Slave addresses: 1 to 207
Modbus RS485		<pre>Supervision E17 BMS communication Modbus RS485 Baud rate 19200 Address 001 Parity None Stop Bit 2</pre>	No	- Baudrate: 1200 to 19200 - Parity: None, Even or Odd - Nbr. stop bits: 1 or 2 - Slave addresses: 1 to 207
Modbus TCP/IP		<pre>Supervision E17 BMS communication Modbus IP</pre>	No	
Bacnet IP		<pre>Supervision E17 BMS communication Bacnet IP</pre>	No	

Protocol	Communication card reference	Typical parameter settings in the controller	Interface file required?	Available settings
Bacnet MS/TP			No	
LON			Yes (Xif and Nxe file)	

Communication table for Bacnet IP

Variable	UOM	R/W	BACNET IP		
			Obj_Type	Obj_Instance	Obj_Name
Fluid outlet temperature	°C	R	analog	100001	A0001
Ambient temperature	°C	R	analog	100003	A0003
AD switchpoint 1	°C	R/W	analog	100004	A0004
AD switchpoint 2	°C	R/W	analog	100005	A0005
Night quiet mode: AD switchpoint 1	°C	R/W	analog	100008	A0008
Night quiet mode: AD switchpoint 2	°C	R/W	analog	100009	A0009
Active setpoint	°C	R	analog	100010	A0010
Regular setpoint	°C	R/W	analog	100011	A0011
Free cooling setpoint	°C	R/W	analog	100012	A0012
Proportional band	°C	R/W	analog	100015	A0015
Night quiet mode: daytime speed limit	%	R/W	analog	100016	A0016
Night quiet mode: night time speed limit	%	R/W	analog	100017	A0017
Daytime clock: Monday start hours	h	R/W	analog	200006	I0006
Daytime clock: Monday start minutes	m	R/W	analog	200007	I0007
Daytime clock: Monday end hours	h	R/W	analog	200008	I0008
Daytime clock: Monday end minutes	m	R/W	analog	200009	I0009
Daytime clock: Tuesday start hours	h	R/W	analog	200010	I0010
Daytime clock: Tuesday start minutes	m	R/W	analog	200011	I0011
Daytime clock: Tuesday end hours	h	R/W	analog	200012	I0012
Daytime clock: Tuesday end minutes	m	R/W	analog	200013	I0013
Daytime clock: Wednesday start hours	h	R/W	analog	200014	I0014
Daytime clock: Wednesday start minutes	m	R/W	analog	200015	I0015
Daytime clock: Wednesday end hours	h	R/W	analog	200016	I0016
Daytime clock: Wednesday end minutes	m	R/W	analog	200017	I0017
Daytime clock: Thursday start hours	h	R/W	analog	200018	I0018
Daytime clock: Thursday start minutes	m	R/W	analog	200019	I0019
Daytime clock: Thursday end hours	h	R/W	analog	200020	I0020
Daytime clock: Thursday end minutes	m	R/W	analog	200021	I0021
Daytime clock: Friday start hours	h	R/W	analog	200022	I0022
Daytime clock: Friday start minutes	m	R/W	analog	200023	I0023
Daytime clock: Friday end hours	h	R/W	analog	200024	I0024
Daytime clock: Friday end minutes	m	R/W	analog	200025	I0025



Variable	UOM	R/W	BACNET IP		
			Obj_ Type	Obj_ Instance	Obj_ Name
Daytime clock: Saturday start hours	h	R/W	analog	200026	I0026
Daytime clock: Saturday start minutes	m	R/W	analog	200027	I0027
Daytime clock: Saturday end hours	h	R/W	analog	200028	I0028
Daytime clock: Saturday end minutes	m	R/W	analog	200029	I0029
Daytime clock: Sunday start hours	h	R/W	analog	200030	I0030
Daytime clock: Sunday start minutes	m	R/W	analog	200031	I0031
Daytime clock: Sunday end hours	h	R/W	analog	200032	I0032
Daytime clock: Sunday end minutes	m	R/W	analog	200033	I0033
Night quiet mode - Control type (0: clock - 1: via BMS)	---	R/W	analog	200034	I0034
Integration time	sec	R/W	analog	200036	I0036
Cleaning cycle: interval	days	R/W	analog	200037	I0037
Cleaning cycle: duration	min	R/W	analog	200038	I0038
AD ON fan speed	%	R/W	analog	200039	I0039
AD OFF fan speed	%	R/W	analog	200040	I0040
AD ON delay	sec	R/W	analog	200041	I0041
AD OFF delay	sec	R/W	analog	200042	I0042
Unit pLAN address	---	R	analog	200050	I0050
Pre-cooling Deactivation function: start day	---	R/W	analog	200055	I0055
Pre-cooling Deactivation function: start month	---	R/W	analog	200056	I0056
Pre-cooling Deactivation function: end day	---	R/W	analog	200057	I0057
Pre-cooling Deactivation function: end month	---	R/W	analog	200058	I0058
Pre-cooling Deactivation function: start hour	h	R/W	analog	200059	I0059
Pre-cooling Deactivation function: end hour	h	R/W	analog	200061	I0061
Alarm delay	sec	R/W	analog	200067	I0067
Sensor alarm delay	sec	R/W	analog	200068	I0068
Fan speed	%	R	analog	200076	I0076
EC fan N°2: actual speed	rpm	R	analog	200077	I0077
EC fan N°2: maximum allowable speed	rpm	R	analog	200078	I0078
EC fan N°2: actual power	W	R	analog	200079	I0079
EC fan N°3: actual speed	rpm	R	analog	200081	I0081
EC fan N°3: maximum allowable speed	rpm	R	analog	200082	I0082
EC fan N°3: actual power	W	R	analog	200083	I0083
EC fan N°4: actual speed	rpm	R	analog	200085	I0085
EC fan N°4: maximum allowable speed	rpm	R	analog	200086	I0086
EC fan N°4: actual power	W	R	analog	200087	I0087
EC fan N°5: actual speed	rpm	R	analog	200089	I0089
EC fan N°5: maximum allowable speed	rpm	R	analog	200090	I0090
EC fan N°5: actual power	W	R	analog	200091	I0091
EC fan N°6: actual speed	rpm	R	analog	200093	I0093
EC fan N°6: maximum allowable speed	rpm	R	analog	200094	I0094
EC fan N°6: actual power	W	R	analog	200095	I0095
EC fan N°7: actual speed	rpm	R	analog	200097	I0097
EC fan N°7: maximum allowable speed	rpm	R	analog	200098	I0098
EC fan N°7: actual power	W	R	analog	200099	I0099
EC fan N°8: actual speed	rpm	R	analog	200101	I0101
EC fan N°8: maximum allowable speed	rpm	R	analog	200102	I0102
EC fan N°8: actual power	W	R	analog	200103	I0103
EC fan N°9: actual speed	rpm	R	analog	200105	I0105
EC fan N°9: maximum allowable speed	rpm	R	analog	200106	I0106
EC fan N°9: actual power	W	R	analog	200107	I0107
EC fan N°10: actual speed	rpm	R	analog	200109	I0109
EC fan N°10: maximum allowable speed	rpm	R	analog	200110	I0110
EC fan N°10: actual power	W	R	analog	200111	I0111

Variable	UOM	R/W	BACNET IP		
			Obj_Type	Obj_Instance	Obj_Name
EC fan N°11: actual speed	rpm	R	analog	200113	I0113
EC fan N°11: maximum allowable speed	rpm	R	analog	200114	I0114
EC fan N°11: actual power	W	R	analog	200115	I0115
EC fan N°12: actual speed	rpm	R	analog	200117	I0117
EC fan N°12: maximum allowable speed	rpm	R	analog	200118	I0118
EC fan N°12: actual power	W	R	analog	200119	I0119
EC fan N°13: actual speed	rpm	R	analog	200121	I0121
EC fan N°13: maximum allowable speed	rpm	R	analog	200122	I0122
EC fan N°13: actual power	W	R	analog	200123	I0123
EC fan N°14: actual speed	rpm	R	analog	200125	I0125
EC fan N°14: maximum allowable speed	rpm	R	analog	200126	I0126
EC fan N°14: actual power	W	R	analog	200127	I0127
EC fan N°15: actual speed	rpm	R	analog	200129	I0129
EC fan N°15: maximum allowable speed	rpm	R	analog	200130	I0130
EC fan N°15: actual power	W	R	analog	200131	I0131
Standard/Free cooling switch over (0: Standard / 1: Free cooling)	---	R/W	binary	100001	D0001
Free cooling status (0: OFF / 1: ON)	---	R	binary	100002	D0002
Night quiet mode (0: disable / 1: enable)	---	R/W	binary	100004	D0004
Night quiet mode status (0: not active / 1:active)	---	R	binary	100005	D0005
Night quiet mode: clock mode active (0: NO / 1: YES)	---	R	binary	100006	D0006
Night quiet mode: BMS mode active (0: NO / 1: YES)	---	R	binary	100007	D0007
Night quiet mode day/night time speedlimit via BMS (0: night / 1: day)	---	R/W	binary	100008	D0008
Run authorization (0: OFF / 1: ON)	---	R/W	binary	100009	D0009
Cleaning cycle (0: disable / 1: enable)	---	R/W	binary	100010	D0010
Pre-cooling deactivation function (0: disable / 1: enable)	---	R/W	binary	100011	D0011
NO1 relay output status - Alarm(s) (0:No Alarm / 1:Alarm)	---	R	binary	100013	D0013
NO2 relay output status- Warning(s) (0:No Warning / 1:Warning)	---	R	binary	100014	D0014
NO3 relay output status- RH pre-cooler (0:open / 1:closed)	---	R	binary	100015	D0015
NO4 relay output status - LH pre-cooler (0:open / 1:closed)	---	R	binary	100016	D0016
NO6 relay output status - Run indication (0:Stopped / 1:Running)	---	R	binary	100018	D0018
B6 Dig In status - Free cooling mode (0: Disabled / 1: Enabled)	---	R	binary	100021	D0021
ID1 (0: Off / 1:On) - Remote start/stop status	---	R	binary	100022	D0022
Alarm sensor B1 (fluid outlet temperature sensor)	---	R	binary	100024	D0024
Fan N°2 - alarm/warning present	---	R	binary	100029	D0029
Fan N°3 - alarm/warning present	---	R	binary	100030	D0030
Fan N°4 - alarm/warning present	---	R	binary	100031	D0031
Fan N°5 - alarm/warning present	---	R	binary	100032	D0032
Fan N°6 - alarm/warning present	---	R	binary	100033	D0033
Fan N°7 - alarm/warning present	---	R	binary	100034	D0034
Fan N°8 - alarm/warning present	---	R	binary	100035	D0035
Fan N°9 - alarm/warning present	---	R	binary	100036	D0036
Fan N°10 - alarm/warning present	---	R	binary	100037	D0037
Fan N°11 - alarm/warning present	---	R	binary	100038	D0038
Fan N°12 - alarm/warning present	---	R	binary	100039	D0039
Fan N°13 - alarm/warning present	---	R	binary	100040	D0040
Fan N°14 - alarm/warning present	---	R	binary	100041	D0041
Fan N°15 - alarm/warning present	---	R	binary	100042	D0042



Variable	UOM	R/W	BACNET IP		
			Obj_ Type	Obj_ Instance	Obj_ Name
Alarm present	---	R	binary	100059	D0059
Unit status (0: OFF / 1: ON)	---	R	binary	100063	D0063
Warning present	---	R	binary	100066	D0066
Alarm sensor B4 (ambient temperature sensor)	---	R	binary	100067	D0067

Commissioning guide Bacnet IP

This guide will show the commissioning procedure to activate the Carel PLC with the Bacnet IP protocol.

Requirements:

- PC/Laptop
- Ethernet (UTP) cable (crossover cable)
- Carel PLC with Carel pCOWeb SE Card (PCO1000WDO)

Next steps will be executed during this guide:

1. Configuration of the PC/laptop for direct connection to pCOWeb
2. Check the configuration of the Carel PLC
3. Starting the pCOWeb card with the default settings
4. Configuration of the pCOWeb card
5. Adjust factory settings

PC CONFIGURATION

IP address and subnet mask

The pCOWeb card has next default settings:

Static IP address	172.16.0.1
Subnet mask	255.255.0.0
Port	BAC0 (=BACzero)

To set up a network with the PLC you need to adjust your PC settings:

Enter the Static IP address	172.16.0.2
Enter the Subnet mask	255.255.0.0

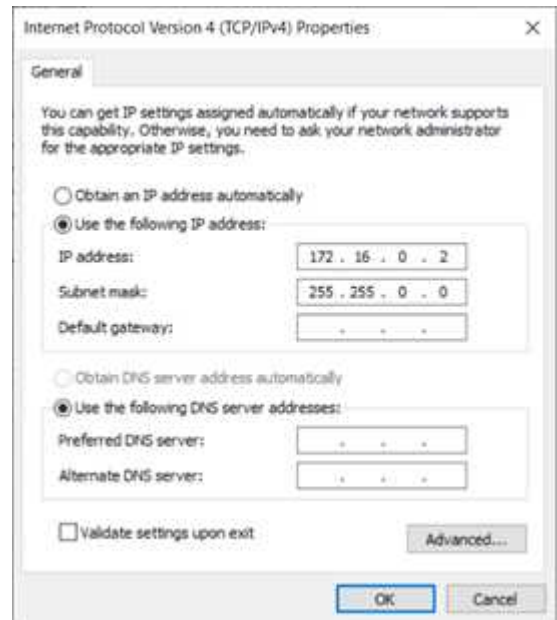
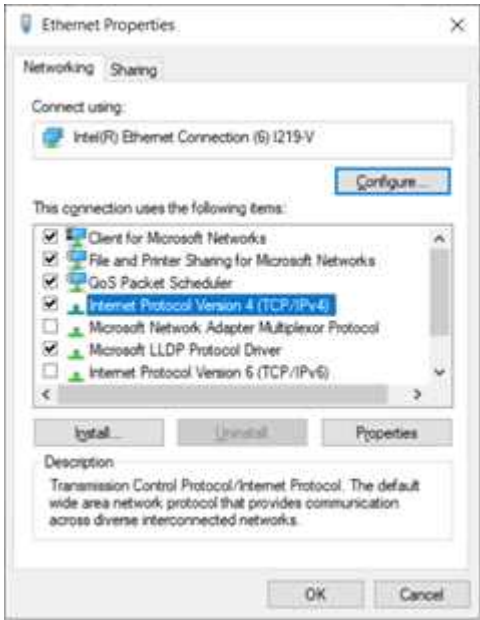

Wait for 1 minute for the PLC to reboot and go to the Information page. The reboot will be finished when the Information page is accessible. If the Information page is not accessible after 2 minutes, you will have to switch the power from the controller off & on. After the start up the information will be visible again.

Proxy server settings

If the proxy server is not disabled, communication with the pCOWeb card is not possible. Make sure that the proxy server is disabled.

1. Go to your Control Panel
2. Select "Internet Options"
3. Select "Connections"
4. Go the "Lan Settings"
5. Make sure that the proxy server is disabled

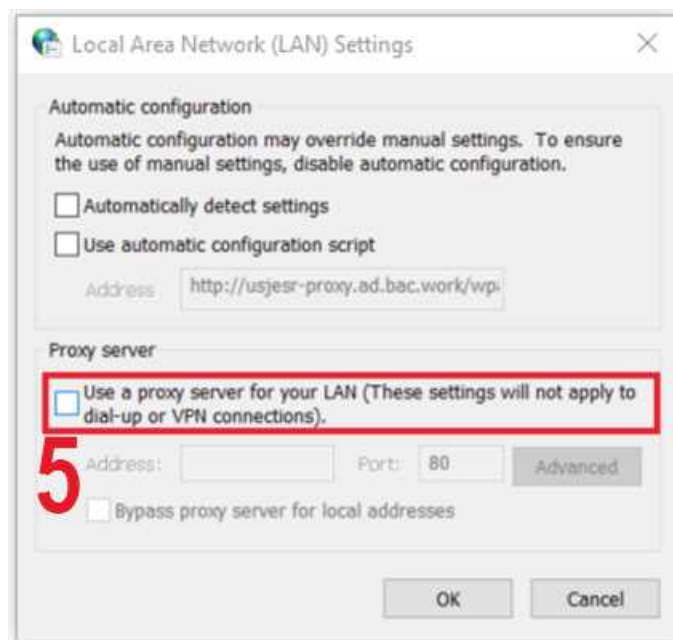

CONFIGURATION OF CAREL PLC

Make sure the Carel PLC is configured correctly on the controller itself.

- Go to the User (E) Menu
- Enter the password "0000"
- Go to the User screen E17
- Define the protocol as Bacnet IP



STARTING PCOWEB AND ACTIVATING THE DEFAULT NETWORK SETTINGS.

Connect the PLC via the UTP cable to your PC (crossover cable).
Power the Carel PLC while pushing the setup button on the pCOWeb card.



The status LED will be green while you hold the button.
After ± 10 seconds, the LED will start flashing red slowly.
Release the button before the LED flashes red 3 times.
Now the pCOWeb card is started with the default settings.
The card will confirm that the start up was performed correctly by turning steady green for 1 minute. After this minute, the green status LED will continuously flash to indicate that the status is OK.

 The left "STATUS" LED indicates the communication status between the pCOWeb card the Carel PLC.
A red flashing LED status indicates that there is a communication problem between the PLC and the card. This can be a configuration problem or a hardware problem. A green LED will continuously flash to indicate that the status is OK.

The left "NETWORK" LED indicates the communication status between the pCOWeb card the IP network. A red flashing LED status indicates that there is a communication problem between the card and the IP network. This can be a configuration problem or a hardware problem. A green LED will continuously flash to indicate that the status is OK.

CONFIGURATION VIA PCOWEB

Open your internet explorer (preferably Chrome) and enter `http://172.16.0.1` in the address field. It might be necessary to **turn off your fire wall and anti-virus settings** to enter the web server.

Enter the administrator page by using the next identifiers:

Username: admin

Password: fadmin

1. Go to the menu Configuration
2. Enter the tab "pCO Com"
3. Make sure that the configuration is changed to the settings as given in the image below
4. Now press "Submit"
5. Now press "Reboot"

The screenshot shows the pCOWeb web interface. On the left is a navigation menu with 'Configuration' highlighted (1). The main content area has tabs for 'General', 'Network', 'pCO Com' (2), 'ModbusTCP', and 'SNMP'. Under 'pCO Com', the 'Serial communication' section is visible. It includes a 'Submit' button (4) and a table of variable ranges (3):

Protocol	Modbus Extended	
Baud rate	19200	default 19200
Communication start-up	<input type="radio"/> Fast <input checked="" type="radio"/> Compatible	
Modbus slave address	1	1 to 247
Digital variables*	2048	1 to 2048
Analog variables*	5000	1 to 5000
Integer variables*	5000	1 to 5000

At the bottom of the interface is a 'REBOOT' button (5). The left sidebar also shows system information like 'System is using: Factory parameters', 'Firmware Release: A2.1.2 - B2.1.2', 'Mac Address: 00:0a:5c:91:46:af', and 'pCOWeb's date: 1970-01-01 02:28'.

Wait for 1 minute for the PLC to reboot and go to the Information page. The reboot will be finished when the Information page is accessible. If the Information page is not accessible after 2 minutes, you will have to switch the power from the controller off & on. After the start up the information will be visible again.



Digital Variables	Up to 500			1000			1500				
1-20	0	0	1	0	0	1	0	0	1	1	0
21-40	0	1	0	0	0	0	0	0	1	1	1
41-60	0	0	1	0	0	0	0	0	0	0	0
61-80	0	0	1	0	0	0	0	0	0	1	0
81-100	0	0	0	0	0	0	0	0	0	0	0
101-120	0	0	0	0	0	0	0	0	0	0	0
121-140	0	0	0	0	0	0	0	0	0	0	0
141-160	0	0	0	0	0	0	0	0	0	0	0
161-180	0	0	0	0	0	0	0	0	0	0	0
181-200	0	0	0	0	0	0	0	0	0	0	0
201-220	0	0	0	0	0	0	0	0	0	0	0
221-240	0	0	0	0	0	0	0	0	0	0	0
241-260	0	0	0	0	0	0	0	0	0	0	0
261-280	0	0	0	0	0	0	0	0	0	0	0
281-300	0	0	0	0	0	0	0	0	0	0	0
301-320	0	0	0	0	0	0	0	0	0	0	0
321-340	0	0	0	0	0	0	0	0	0	0	0
341-360	0	0	0	0	0	0	0	0	0	0	0
361-380	0	0	0	0	0	0	0	0	0	0	0
381-400	0	0	0	0	0	0	0	0	0	0	0
401-420	0	0	0	0	0	0	0	0	0	0	0
421-440	0	0	0	0	0	0	0	0	0	0	0
441-460	0	0	0	0	0	0	0	0	0	0	0
461-480	0	0	0	0	0	0	0	0	0	0	0
481-500	0	0	0	0	0	0	0	0	0	0	0

In case all variables are visible the configuration between the PLC and the pCOWeb card is completed. In case all values are presented as "U" you will need to repeat previous steps and make sure all the parameters are set correctly according to above instructions. If all variables are different from "U" the configuration is OK.

Activating the Modbus IP protocol by using the web interface

1. Go to the menu Configuration
2. Enter the tab "Bacnet"
3. Make sure that the configuration is changed to the settings as given in the image below
4. Now press "Submit"
5. Now press "Reboot"

Wait for 1 minute for the PLC to reboot and go to the Information page. The reboot will be finished when the Information page is accessible. If the Information page is not accessible after 2 minutes, you will have to switch the power from the controller off & on. After the start up the information will be visible again.

ADJUST FACTORY SETTINGS

You can adjust the factory settings for the Modbus IP protocol in the next pages. For every adjustment you will need to "Submit" and "Reboot" the controller as in the previous steps.



For extra information you can consult the Carel Knowledge Sharing Area (KSA):
<https://ksa.carel.com/home>

Once you created a login account you can check all the documentation of Carel. You can find the pCOWeb information under Sw&Support / pCOWeb & pCOnet / pCOWeb / Documents and Media

More information

REFERENCE LITERATURE

- Eurovent 9-5 (6) Recommended Code of Practice to keep your Cooling System efficient and safe. Eurovent/Cecomaf, 2002, 30p.
- Guide des Bonnes Pratiques, Legionella et Tours Aéroréfrigérantes. Ministères de l'Emploi et de la Solidarité, Ministère de l'Economie des Finances et de l'Industrie, Ministère de l'Environnement, Juin 2001, 54p.
- Voorkom Legionellose. Ministerie van de Vlaamse Gemeenschap. December 2002, 77p.
- Legionnaires' Disease. The Control of Legionella Bacteria in Water Systems. Health & Safety Commission. 2000, 62p.
- Hygienische Anforderungen an raumlufttechnische Anlagen. VDI 6022.

INTERESTING WEBSITES

Baltimore Aircoil Company	www.BaltimoreAircoil.com
BAC Service website	www.BACservice.eu
Eurovent	www.eurovent-certification.com
European Working Group on Legionella Infections (EWGLI)	EWGLI
ASHRAE	www.ashrae.org
Uniclimate	www.uniclimate.fr
Association des Ingénieurs et techniciens en Climatique, Ventilation et Froid	www.aicvf.org
Health and Safety Executive	www.hse.gov.uk

ORIGINAL DOCUMENTATION



This manual is originally made in English. Translations are provided for your convenience. In the event of discrepancies, the English original text shall prevail over the translation.

The service expert for BAC equipment

We offer tailored services and solution for BAC cooling towers and equipment.

- Original spare parts and fill -for an efficient, safe and year round reliable operation.
- Service solutions - preventive maintenance, repairs, refurbishments, cleaning and disinfection for reliable trouble-free operation.
- Upgrades and new technologies - save up energy and improve maintenance by upgrading your system.
- Water treatment solutions - equipment for controlling corrosion scaling and proliferation of bacteria.

For more details, contact your local BAC representative for further information and specific assistance at www.BACservice.eu



A series of horizontal dotted lines for writing, spanning the width of the page.



A series of horizontal dotted lines spanning the width of the page, providing a template for handwritten notes or a checklist.





A series of horizontal dotted lines for writing, spanning the width of the page.



A series of horizontal dotted lines spanning the width of the page, providing a template for writing or drawing.





A series of horizontal dotted lines for writing, spanning the width of the page.



A series of horizontal dotted lines spanning the width of the page, providing a template for writing or data entry.



COOLING TOWERS

CLOSED CIRCUIT COOLING TOWERS

ICE THERMAL STORAGE

EVAPORATIVE CONDENSERS

HYBRID PRODUCTS

PARTS, EQUIPMENTS & SERVICES

BLUE by nature
GREEN at heart



www.BaltimoreAircoil.com

Europe@BaltimoreAircoil.com

Please refer to our website for local contact details.

Industriepark - Zone A, B-2220 Heist-op-den-Berg, Belgium

© Baltimore Aircoil International nv