



**BALTIMORE
AIRCOIL COMPANY**

TVFC-RC Adiabatic Cooler Recirculation Mode

SOFTWARE INSTRUCTIONS

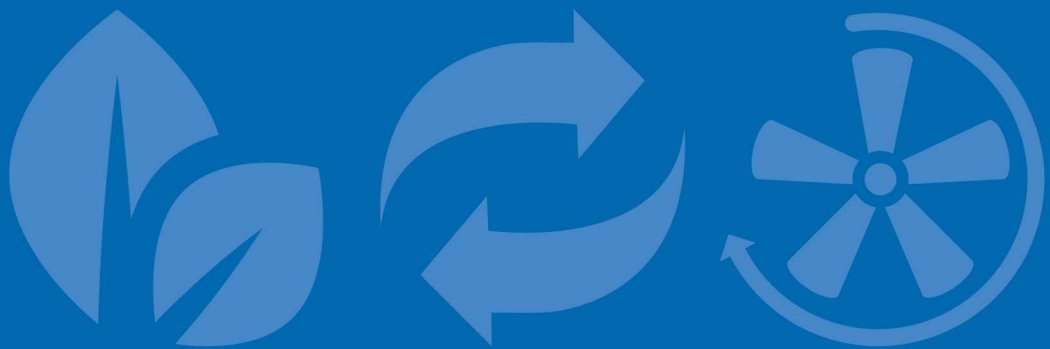



Table of contents

SOFTWARE INSTRUCTIONS

1	Scope	3
	Recirculation execution	3
2	Control Logic	4
3	Programmable logic controller	6
	Programmable Logic Controller (PLC)	6
	Display and operations	6
4	Software	8
	Menu overview	8
	Main Loop Menu (P)	9
	User Menu (E)	10
	Working Time Menu (T)	15
	Inputs Outputs Menu (I)	15
	Clock Menu (K)	16
	Logger Menu (H)	17
	System Information (S)	17
	Maintenance Menu (M)	18
5	Alarms and Warnings overview	20
	Alarms overview	20
6	BMS Communication	22
	Available communication protocols and communication cards	22
	Communication table for Modbus RS485	23
	Commissioning guide Modbus RS485	26
7	Further Assistance & Information	29
	More information	29
	The service expert for BAC equipment	29

This manual applies to units configured in Recirculation mode operating on BAC software version V2.0.15B or later, in recirculation mode.

Recirculation execution

The TVFC is a V-shaped dry cooler equipped with **adiabatic pre-coolers (1)** that cool the warm **process fluid (2)** by sensible heat transfer. **Water flows (3)** evenly over evaporative cooling pads located in front of the **dry finned coil (4)**. With the **make up (9)** situated on top of the pads, adiabatic precooling of the air can also be guaranteed when the pump is not in operation. **Axial (5) fans** draw **air (6)** through the pads where a portion of the water evaporates and cools down the saturated air. This increases the cooling capacity of the incoming air for cooling the **process fluid (7)** inside the coil. The **recirculation system (8)** can further reduce the total water consumption.

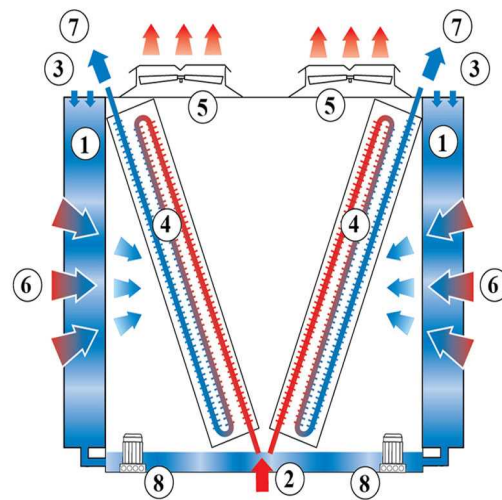

CONTROL LOGIC

The controller controls the fan speed based on the actual fluid outlet temperature and the standard or free-cooling set point, ensuring a minimum electrical consumption and noise level. The PLC will operate as described in the flow chart that follows.

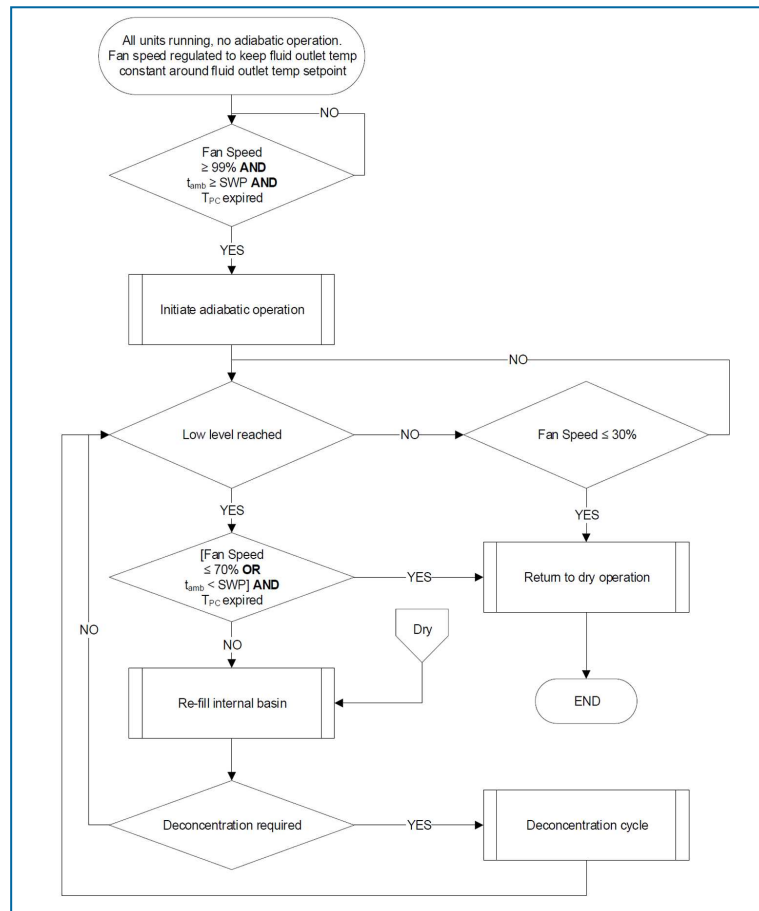

The standard set-point, the free-cooling set-point and the ambient temperature switch-point are adjustable via the User Menu. The controller continuously measures the fluid outlet temperature via a temperature sensor installed in the fluid out pipe and the ambient temperature via a temperature sensor that is factory installed on the unit.

The PLC is pre-programmed and ready for operation. However, depending on the size of the installation, you may need to adjust the pre-programmed parameters during start-up.



CAUTION

Changing the controller's parameters may result in an undesired operation of the unit such as a hunting phenomenon, premature activation of pre-cooling (hence increased water consumption) or in late pre-cooling activation resulting in fluid outlet temperatures exceeding the design temperature.

Programmable Logic Controller (PLC)

The PLC with built-in display:







Display and operations

The controller display contains the screen and six operation keys.

The screen allows eight lines of text. The screen title and the screen reference are always on the top line.

Use the operation keys to navigate between the different menus and screens.

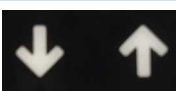
	Alarm key	Display the alarm menu.
	Menu key	Display the main menu screen.

	Back key	Revert to the previous step or menu.
	Arrow keys	Navigate between the different screens and menus.
	Enter key	Select the marked menu or parameter or enable the change of a parameter.



Menu overview

Menu	Screen reference	Function
Main loop	P	Readout: <ul style="list-style-type: none">- The unit status (ON/OFF)- The fluid outlet and ambient temperature- The fan speed- The pre-cooler status
User	E	Set: <ul style="list-style-type: none">- Run authorisation / local ON/OFF- Standard and free-cooling set-point- PI parameters- Ambient temperature switch point for Adiabatic pre-cooling- Adiabatic pre-cooler delay- Adiabatic pre-cooler cleaning cycle- Night quiet mode- Time delay on alarm messages- BMS communication settings The standard password for the User Menu is "1234".
Manufacturer	C	This menu is password protected and is not accessible to unauthorized personnel.
Working time	T	Readout the operating hours for the fans and adiabatic pre-cooling.
Inputs/outputs:	I	Readout the input and output status.
Clock	K	Set the correct time and date.
Logger	H	Readout the alarm and warning history.
System info	S	Readout the software and bios version.
Maintenance	M	Set the inputs and outputs manually for test purposes. The standard password for the Maintenance menu is "9876".

Main Loop Menu (P)



The screens in the Main Loop Menu are read-only and cannot be edited.

Screen P01



Main screen with general information:

- The current time and date.
- The unit serial number and pLAN address: “Ad: 0”.
- “Setpoint”: the active setpoint for the fluid outlet temperature.
- “Tout”: the measured fluid outlet temperature.
- “Tamb”: the measured ambient temperature.
- “Fan speed”: the current fan speed.
- The unit status: “ON” or “OFF”.

Note

Unit status ON implies that the unit is ready to automatically respond to any heat rejection requirement, even in case the fans are temporarily deactivated due to the absence of a heat load.

Screen P03

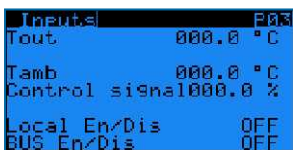

Overview of all inputs:

- “Tout”: the measured fluid outlet temperature.
- “Tamb”: the measured ambient temperature.
- “Control signal”: the calculated fan speed reference.
- “Local En/Dis”: the status of the remote start/stop (dry contact between terminals Y4:1-Y4:4).
- “BUS En/Dis”: the status of the BMS controlled variable “Run authorization” (refer to screen E02).

Screen P04

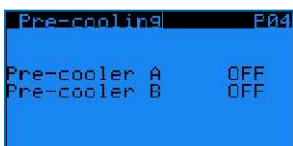

Adiabatic pre-cooling status:

- “Pre-cooler A”: shows the status of the adiabatic pre-cooler on side A.
- “Pre-cooler B”: shows the status of the adiabatic pre-cooler on side B.

Screen P05

```

Pre-cooling P05
Program state
0: Dry op./Wait AD op.
Tpc 00000 ---
Tcwy 00000 ---
Td 00000 ---
Tp 00000 ---
Deconc. counter 00
  
```

Adiabatic pre-cooling status: readout the status of the different timers and the deconcentration counter:

- “**Tpc**”: pre-cooling timer, delays the activation and deactivation of the adiabatic pre-cooling.
- “**Tcwy**”: city water valve timer: extends the city water supply after the pump has started.
- “**Td**”: drain valve timer, delays emptying of the sump.
- “**Tp**”: pump timer, protects the pump against running dry.
- “**Deconc. Counter**”: counts the number of sump refills.

Screen P10-P51

```

rpmFan_EBM_fan_HV2_P10
Offline Addr:002
Current speed 0000rpm
Max speed 00000 rpm
Power 00000W
Current 00000 mA
  
```

EC fan information screens:

- The fan status: “**Online**” or “**Offline**” and fan address: “**Addr: 002**”.
- “**Current speed**”: the actual fan speed.
- “**Max speed**”: the maximum allowable fan speed.
- “**Power**”: the actual power of the EC fan.
- “**Current**”: the actual current of the EC fan.

Note

In case an EC fan shows the status “Offline”, check the power supply to the fan and the Modbus communication wiring to the fan.

User Menu (E)



The screens in the User Menu are editable. The standard password is “1234”.

Screen E01

```

Language E01
Language
French
Site name
BACH1607697 01
  
```

- “**Language**”: set the controller language to English, French, Dutch, Spanish or German.
- “**Site name**”: enter the unit serial number or the site name.

Screen E02

```

Setpoints E02
Run authorisation OFF
Setpoints
Standard 30.0° C
Free cooling 10.0° C
  
```

- “**Run authorization**”: activate or deactivate the unit. This variable can either be set directly in this screen or via a BMS variable (see section 6: BMS communication).
- “**Standard setpoint**”: the default setpoint for the fluid outlet temperature.

- **“Free cooling setpoint”**: the setpoint for the fluid outlet temperature when the unit operates in free cooling mode. Switch over to free cooling mode via a BMS controlled variable or via the dry contact between terminals Y4:2-Y4:4.

Example

*The controller controls the fan speed based on the actual fluid outlet temperature and the standard setpoint when the dry contact between terminals Y4:2-Y4:4 is open.
When the dry contact between terminals Y4:2-Y4:4 is closed, the controller controls the fan speed based on the actual fluid outlet temperature and the free cooling setpoint.*

Screen E03



PI-parameters: these parameters determine the unit’s reaction speed to changes in fluid outlet temperature.

- **“Prop. Band”**: set the value for the proportional band of the PI controller.
- **“Integr. Time”**: set the value for the integration time of the PI controller.



CAUTION

Changing the PI-Parameters may result in a hunting phenomenon.

Note

Make the unit react faster to changes in fluid outlet temperature by decreasing the proportional band and the integration time, or make the unit react slower by increasing the proportional band and integration time.

Screen E04

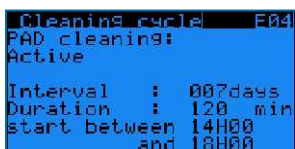

Cleaning cycle for the adiabatic pre-coolers:

- **“PAD cleaning”**: allows you to enable or disable the cleaning cycle function.
- **“Interval”**: set the period (the number of days the adiabatic pre-cooling has not functioned) after which the cleaning cycle must activate.
- **“Duration”**: set the duration for the pre-cooler cleaning cycle.
- Set the time interval for the start of the cleaning cycle.

Example

The pre-cooler cleaning cycle activates the pre-coolers during 120 minutes when the unit has not operated adiabatically for a period of 7 days. The cleaning cycle starts between 14h00 and 18h00.

Note

The controller automatically disables the cleaning cycle when the ambient temperature is below 4°C.

Screens E07-E08-E09

```
AD switchpointl E07
Setpoint      25.0°C
Fan speed ON  099%
Fan speed OFF 070%
Fan speed OFF lim.030%
(De)activation delay
pre-clr(Tpc) 0300sec
```

```
AD switchpointl E08
Time extension
make-up: TCWU 0060sec
Sump refill
timer: TP      5940sec
```

```
AD switch pointl E09
Sump drain
delay: TD      03600s
Deconcentration after
03refills
Flow det. delay 005s
(999s to disable)
```

Adiabatic pre-cooler temperature and fan speed switchpoints and timers:

- **“Setpoint”**: the temperature switchpoint for the activation of the adiabatic pre-cooling.
- **“Fan speed ON”** and **“Fan speed OFF”**: the fan speed switchpoints for the activation and deactivation of the adiabatic pre-cooling.
- **“Fan speed OFF lim.”**: the fan speed switchpoint for the immediate deactivation of the adiabatic pre-cooling.
- **“(De) activation delay pre-cooler Tpc”**: the time delay for the activation and deactivation of the adiabatic pre-cooling.
- **“Time extension make-up TCWV”**: timer to extend the city water supply after the pump has started.
- **“Sump refill timer Tp”**: time delay to prevent the pump from running dry. If the water level in the sump has not reached high level when Tp expires, AL050 Warning Pump activates.
- **“Sump drain delay Td”**: timer, which delays the emptying of the sump.
- **“Deconcentration after ... refills”**: the number of refill cycles before the deconcentration subroutine activates.
- **“Flow det. delay”**: in case the flow switch detects no flow from the pump, the controller triggers AL005 “Alarm flow detection”.

Example

- The unit initiates adiabatic operation when the ambient temperature > 25.0°C **AND** the fan speed > 99%, after a 300 second delay (Tpc).

In order to initiate adiabatic operation, the unit closes the drain valve and opens the city water supply valve in order to fill the sump. Once the sump is full, the pump starts.

The city water supply valve closes after a 60 second delay (T_cwv).

- The unit returns to dry operation:

a) immediately when the fan speed < 30%.

b) after a 300 second delay (Tpc) when the ambient temperature < 24,9°C and low level reached **OR** the fan speed < 70% and low level reached.

When the unit returns to dry operation, the pump stops and the drain valve opens after a 3600 seconds delay (TD).

- When the unit detects low water level in the sump during adiabatic operation, the refill internal basin subroutine opens the city water valve.

In case the water level in the sump does not reach high level before the sump refill timer TP expires, the pump stops and the controller triggers “AL050 Warning pump”.

- The deconcentration subroutine activates after three refill cycles.

During the deconcentration cycle, the drain valve opens and it stays open until the water level in the sump reaches low level.

Screens E10-E11-E13

```
Night Quiet mode E10
Night Quiet Mode
OFF
Daytime s.limit 100.0%
Night s.limit 080.0%
Control: Clock
```

```
DAYTIME E11
MON from00H00 to00H00
TUE from00H00 to00H00
WED from00H00 to00H00
THU from00H00 to00H00
FRI from00H00 to00H00
SAT from00H00 to00H00
SUN from00H00 to00H00
```

```
Night quiet mode E13
AD switchpoint
in night quiet mode
Switchpoint 15.0°C
```

Night quiet mode: predefine fan speed limits for both day and night time.

- Enable/Disable the Night quiet mode and choose the maximum allowed fan speed during day and night on screen E10:
 - **“Night quiet mode”**: **“ON”** or **“OFF”**: enable or disable the Night quiet mode.

- **"Daytime speed limit"** and **"Night time speed limit"**: set the maximum allowed fan speed during day and night time.
- **"Control"**: choose the activation mode: either via a BMS controlled variable (**"via BMS"**) or via a predefined time daytime schedule in screen E11(**"Clock"**).
- **"Daytime clock"** Set up a time schedule for the daytime speed limit in screen E11: Monday to Sunday, start time to end time.



Outside of this time schedule, the night time speed limit will apply.

- **"Via BMS"**: Use parameter **"Night quiet mode day/night time speed limit via BMS"** to switch between daytime speed limit and night time speed limit (Refer to the communication tables in Chapter 6).
- Set specific adiabatic pre-cooler switchpoints for Night quiet mode operation in screen E12:
 - **"AD switchpnt."**: specific temperature switchpoint for the activation of the adiabatic pre-coolers when the night time speed limit is active.

Example

The Night quiet mode is enabled, with a daytime speed limit of 80% and a night time speed limit of 50%.

During daytime:

*- The pre-cooling will activate when the ambient temperature > 25.0°C **AND** the fan speed > 79.2% (= 99% x 80%) after a 300 second delay (Tpc).*

*- The unit will return to dry operation after a 300 seconds delay (Tpc) when the ambient temperature < 24.9°C **OR** the fan speed > 56% (= 70% x 80%) after a 30 second delay.*

During night time:

*- The pre-cooling will activate when the ambient temperature > 15.0 °C **AND** the fan speed > 49.5% (= 99% x 50%) after a 300 second delay (Tpc).*

*- The unit will return to dry operation after a 300 seconds delay (Tpc) when the ambient temperature < 14.9 °C **OR** the fan speed < 35% (= 70% x 50%) after a 30 second delay.*

Screen E14

```
Pre-cooler deact. E14
Pre-cooler deact.
OFF
From 15/07 to 15/09
From 13:a to 15:00
```

Adiabatic pre-cooling deactivation function:

- **"Pre-cooler deact."**: enable or disable the pre-cooler deactivation function.
- Set the period and the time frame during which the unit deactivates the adiabatic pre-cooling.

Example

When the pre-cooling deactivation function is active, the adiabatic pre-cooling cannot activate between 13:00 and 15:00 o'clock from 15/07 to 15/09.

Screen E17

```
Supervision E17
BMS communication
Modbus RS485
Baud rate 19200
Address 001
Parity None
Stop Bit 2
```

Choose the communication protocol: Modbus RS485, Modbus IP, Carel RS485, LON, BacNet IP or BacNet MSTP. Set the communication speed and network address, when applicable. See section 6: BMS communication.

Screen E18

```
Alarms delay E18
Alarm delay 015s
Sensor alarm delay 060s
Network comm. loss
delay: 030s
```

Alarm detection delays:

- “**Alarm delay**”: time delay for EC fan alarms and warnings.
- “**Sensor alarm delay**”: time delay for alarms from the fluid outlet temperature and ambient temperature sensor.
- “**Network comm. Loss delay**”: time delay for the loss of pLAN communication between units (not applicable for stand-alone operation).

Note | *The network communication loss delay is not applicable to stand alone operation.*

Screens E19-E20

```
Emergency Mode E19
Fan speed in case
of comm. loss between
PCO and EBM EC fan
Emergen. mode: OFF
timeout 05000ms
```

```
Emergency Mode E20
Fan speed in case
of comm. loss between
PCO and EBM EC fan
EM Speed 1 050%
EM Speed 2 050%
Switch Tamb 10.0 °C
```

EC fan emergency mode management:

Enable the EC fan emergency mode to select a fixed fan speed for when the Modbus communication between the controller and the EC fans fails.

In case the EC fan emergency mode is disabled, the fans will continue to operate at the latest known fan speed when the Modbus communication between the controller and the EC fans fails.

- “**Emergen. mode**”: “ON” or “OFF”: enable or disable the EC fan emergency mode.
- “**Timeout**”: time delay before the EC fan emergency mode activates.
- “**EM speed 1**”: the emergency speed reference in case the ambient temperature \geq the ambient temperature switchpoint.
- “**EM speed 2**”: the emergency speed reference in case the ambient temperature $<$ the ambient temperature switchpoint.
- “**Switch Tamb**”: the ambient temperature switchpoint.

Example | *When the EC fan emergency mode is enabled, EM speed 1 is set to 100%, EM speed 2 is set to 50% and Switch Tamb is set to 15°C, the EC fans will start running at a fixed speed of 100% in case the Modbus communication between the controller and the EC fans fails when the ambient temperature is 20°C.*

In case, the Modbus communication between the controller and the EC fans fails when the ambient temperature is 10°C, the EC fans will start running at a fixed speed of 50%.

Screen E21

```
Access code E21
Change
access code:0000
```

Set your own access code for the User Menu.

Working Time Menu (T)



The screens in the Working Time Menu are read only and cannot be edited.

Screen T01



Read the operating time for the EC fans and for the adiabatic pre-cooling, displayed in hours.

Screen T04



Read the operating time for the EC fans, the pump, the make-up valve and the dry operating time displayed in hours.

Inputs Outputs Menu (I)



The screens in the Inputs/Outputs Menu are read only and cannot be edited.

Screens I01-I02



Read the analog inputs on the controller:

- “U1: T°C Tout”: the current fluid outlet temperature.
- “U2: T°C Tgen”: not used.
- “U3: T°C Tamb”: the current ambient temperature.

Screen I03

```
Inputs/Outputs I03
U4-DI:Flow switch    █
ID4-DI:Pump fault    █
ID5-DI:Free Cooling  █
ID1 :On-Off          █
U5 :Float switch     █
□open - █:closed
```

Read the status of the digital inputs on the controller (open/closed):

- “**U4-DI: Flow switch**”: flow switch status (O: no flow / C: flow).
- “**ID4-DI: Pump fault**”: Pump override function (O: disabled / C: enabled).
- “**ID5-DI: Free cooling**”: status of the free cooling mode (dry contact between terminals Y4:2-Y4:4).
- “**ID1: On-Off**”: status of the remote start/stop command (dry contact between terminals Y4:1-Y4:4).
- “**U5: Float switch**”: water level in the sump (O: high level, C: low level).

Screen I04

```
Inputs/Outputs I04
NO8:Alarm(s)        □
NO7:Warning(s)      □
NO3:Make-up         □
NO2:Drain           □
NO5:Pump            □
NO6:Operational     □
□open - █:closed
```

Read the status of the digital outputs on the controller (open/closed).

- “**NO8: Alarm(s)**”: closed contact means that there are one or more alarms active.
- “**NO7: Warning(s)**”: a closed contact means that there are one or more warnings active.
- “**NO3: Make-up**”: a closed contact means that the city water valve is open.
- “**NO2: Drain**”: a closed contact means that the drain valve is closed.
- “**NO5: Pump**”: a closed contact means that the pump is running.
- “**NO6: Operational**”: run indication, a closed contact means that the fans are running.

Screen I05

```
Inputs/Outputs I05
Y3:N.U              00.0 U
Y4:Fan speed       00.0 U
```

Read the analog outputs on the controller:

- “**Y3: N.U**”: not used.
- “**Y4: Fan speed**”: a 0-10 Volt control signal, which corresponds to the actual fan speed.
(0 V = 0%, 10 V = 100%)

Clock Menu (K)



The screen in the Clock Menu is editable.

Screen K01



Set the correct time and date. Time format: HH:MM:SS and date format: DD/MM/YY.
The software automatically adjusts to Daylight Saving Time.

Logger Menu (H)



The screens in the Logger Menu are read only and cannot be edited.

Screen H01



Read the history of past alarms.
The log shows the alarm message and the time the alarm occurred.

System Information (S)



The screens in System Information are read only and cannot be edited.

Screen S01

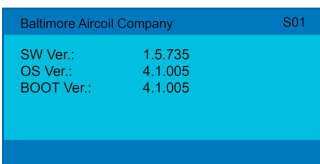

"**SW Ver.**": Current software version installed

"**OS Ver.**": Operating system version

"**BOOT Ver.**": Current boot version

Maintenance Menu (M)

Screen M01

```

MAINTENANCE M01
Sensor offset
Out.let (U1) 000.0 °C
  Corr.:000.0 °C
General (U2) 000.0 °C
  Corr.:000.0 °C
Tamb (U3) 0000.0 °C
  Corr.:000.0 °C
  
```

Program a sensor offset (“**Corr. :**”) to correct the temperature readings for the fluid outlet temperature sensor (“**Outlet (U1)**”) and the ambient temperature sensor (“**Tamb (U3)**”).

The general outlet temperature sensor is not used in stand-alone operation.

Screen M02

```

MAINTENANCE M02
Test mode: OFF
Duration: 015min
  
```

Activate the test mode, which allows to manually set analog and digital outputs and control the EC fans.

- “**Test mode**”: activate or deactivate the test mode.
- “**Duration**”: time delay after which the test mode automatically deactivates.

Note

1. Duration set to 999 min keeps the test mode ON indefinitely
2. When the test mode is set to OFF, screens M03 to M07 are invisible.

Note

When the test mode ends, the controller will show a pop up screen saying "Test mode ended please reboot controller". Reboot the controller to assure that all inputs and outputs are cleared before resuming automatic operation.

Screen M04

```

Dig. out. override M04
Make-up (N03): □
Drain (N02): □
Pump (N05): □
Run indication(N06): □
Alarm (N08): □
Warning (N07): □
□:Open / ■ : Closed
  
```

Manually set the digital outputs:

- “**Make-up**”: activate or deactivate the city water supply valve.
- “**Drain**”: activate or deactivate the drain valve.
- “**Pump**”: activate or deactivate the pump.
- “**Run indication**”: simulate the run indication.
- “**Alarm**”: simulate an alarm.
- “**Warning**”: simulate a warning.

Screen M05

```

Test mode: M05
Output override
analog:
Y3:000.0 Volt
Y4:000.0 Volt
  
```

Manually set the analog outputs:

- “**Y3**”: not used for a unit with EC fan motors.

- “Y4”: simulate a 0-10 Volt output.

Screen M06

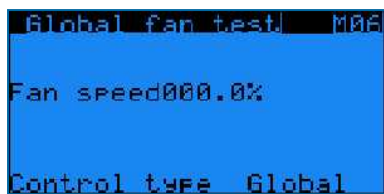

Manually control the EC fans:

- “Fan speed”: 0% to 100%
- “Control type”: choose “Global” to operate all fans simultaneously at the same speed or choose “1 by 1” to set the speed for each fan individually via screen M07.

Screen M07

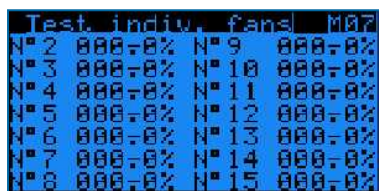

Set the speed for each fan individually.

Alarms overview

- Access the alarms by pressing the alarm button on the controller (triangle with exclamation mark).
- If a particular alarm is no longer present, the alarm message is automatically cleared and the general alarm (NO1) deactivates.
- To see the history of past alarms, check the logger menu.

Note

The Alarm status can be read out via dry contact on terminal Y3: 3/4/5 and the warning status on Y3: 1/2 in the control panel.

Screen AL000

No alarm present.

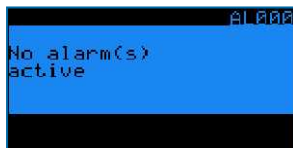

Screen AL001



Fluid outlet temperature sensor (on input U1) is defective.

- Unit stops working.
- Alarm message AL001 on controller display + general alarm (NO1) activates.

Screen AL003



Ambient air temperature sensor (on input U3) is defective.

- Unit remains operational in dry mode, adiabatic operation no longer possible.
- Alarm message AL003 on controller display + general alarm (NO1) activates.

Screen AL005

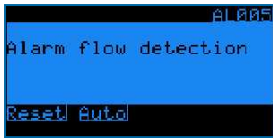

Alarm flow detection.

- The flow sensor detects no flow from the pump.
- The controller stops the pump + displays AL005 + general alarm (NO1) activates.

Screens AL010-AL106



Alarms and warnings from the EC fans. Consult BAC factory for more information.

- Unit remains operational, but the defective fan stops working.

Screen AL050

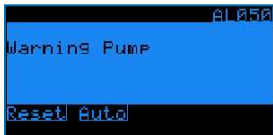

Warning pump





- The sump refill timer TP has expired and the water level in the sump has not yet reached high level.
- The controller stops the pump and displays AL050.





Available communication protocols and communication cards

The following communication protocols are available: Carel RS485, Modbus RS485, Modbus TCP/IP, Bacnet IP, Bacnet MS/TP and LON. The table below shows the required communication card and software settings for each communication protocol.



Based on your selection, this manual will only contain the information you require.

Protocol	Communication card reference	Typical parameter settings in the controller	Interface file required?	Available settings
CAREL RS485		<pre>Supervision E17 BMS communication CAREL RS485 Baud rate 19200 Address 001</pre>	No	- Baudrate: 1200 to 19200 - Slave addresses: 1 to 207
Modbus RS485		<pre>Supervision E17 BMS communication Modbus RS485 Baud rate 19200 Address 001 Parity None Stop Bit 2</pre>	No	- Baudrate: 1200 to 19200 - Parity: None, Even or Odd - Nbr. stop bits: 1 or 2 - Slave addresses: 1 to 207
Modbus TCP/IP		<pre>Supervision E17 BMS communication Modbus IP</pre>	No	
Bacnet IP		<pre>Supervision E17 BMS communication Bacnet IP</pre>	No	

Protocol	Communication card reference	Typical parameter settings in the controller	Interface file required?	Available settings
Bacnet MS/TP			No	
LON			Yes (Xif and Nxe file)	

Communication table for Modbus RS485

Variable	UOM	R/W	Index	Modbus	
				Address	Type
Fluid outlet temperature	°C	R	1	2	register
Ambient temperature	°C	R	3	4	register
AD switchpoint	°C	R/W	6	7	register
Active setpoint	°C	R	10	11	register
Regular setpoint	°C	R/W	11	12	register
Free cooling setpoint	°C	R/W	12	13	register
Night quiet mode: AD switchpoint	°C	R/W	13	14	register
Proportional band	°C	R/W	15	16	register
Night quiet mode: daytime speed limit	%	R/W	18	19	register
Night quiet mode: night time speed limit	%	R/W	19	20	register
Daytime clock: Monday start hours	h	R/W	5007	5008	register
Daytime clock: Monday start minutes	m	R/W	5008	5009	register
Daytime clock: Monday end hours	h	R/W	5009	5010	register
Daytime clock: Monday end minutes	m	R/W	5010	5011	register
Daytime clock: Tuesday start hours	h	R/W	5011	5012	register
Daytime clock: Tuesday start minutes	m	R/W	5012	5013	register
Daytime clock: Tuesday end hours	h	R/W	5013	5014	register
Daytime clock: Tuesday end minutes	m	R/W	5014	5015	register
Daytime clock: Wednesday start hours	h	R/W	5015	5016	register
Daytime clock: Wednesday start minutes	m	R/W	5016	5017	register
Daytime clock: Wednesday end hours	h	R/W	5017	5018	register
Daytime clock: Wednesday end minutes	m	R/W	5018	5019	register
Daytime clock: Thursday start hours	h	R/W	5019	5020	register
Daytime clock: Thursday start minutes	m	R/W	5020	5021	register
Daytime clock: Thursday end hours	h	R/W	5021	5022	register
Daytime clock: Thursday end minutes	m	R/W	5022	5023	register
Daytime clock: Friday start hours	h	R/W	5023	5024	register
Daytime clock: Friday start minutes	m	R/W	5024	5025	register
Daytime clock: Friday end hours	h	R/W	5025	5026	register
Daytime clock: Friday end minutes	m	R/W	5026	5027	register
Daytime clock: Saturday start hours	h	R/W	5027	5028	register
Daytime clock: Saturday start minutes	m	R/W	5028	5029	register
Daytime clock: Saturday end hours	h	R/W	5029	5030	register



Variable	UOM	R/W	Index	Modbus	
				Address	Type
Daytime clock: Saturday end minutes	m	R/W	5030	5031	register
Daytime clock: Sunday start hours	h	R/W	5031	5032	register
Daytime clock: Sunday start minutes	m	R/W	5032	5033	register
Daytime clock: Sunday end hours	h	R/W	5033	5034	register
Daytime clock: Sunday end minutes	m	R/W	5034	5035	register
Night quiet mode: control type (0: clock - 1: via BMS)	---	R/W	5036	5037	register
Integration time	sec	R/W	5037	5038	register
Cleaning cycle: interval	days	R/W	5038	5039	register
Cleaning cycle: duration	min	R/W	5039	5040	register
AD ON fan speed	%	R/W	5044	5045	register
AD OFF fan speed	%	R/W	5045	5046	register
AD OFF fan speed limit	%	R/W	5046	5047	register
AD ON/OFF delay: timer Tpc	sec	R/W	5047	5048	register
Sump refill timer Tp	sec	R/W	5048	5049	register
Time extension make-up Tcww	sec	R/W	5049	5050	register
Sump drain delay Td	sec	R/W	5050	5051	register
Unit pLAN address	---	R	5051	5052	register
# sump refills before activation of the deconcentration cycle	---	R/W	5053	5054	register
Pre-cooling Deactivation function: start day	---	R/W	5056	5057	register
Pre-cooling Deactivation function: start month	---	R/W	5057	5058	register
Pre-cooling Deactivation function: end day	---	R/W	5058	5059	register
Pre-cooling Deactivation function: end month	---	R/W	5059	5060	register
Pre-cooling Deactivation function: start hour	h	R/W	5060	5061	register
Pre-cooling Deactivation function: end hour	h	R/W	5062	5063	register
Alarm delay	sec	R/W	5068	5069	register
Sensor alarm delay	sec	R/W	5069	5070	register
Fan speed	%	R	5077	5078	register
EC fan N°2: actual speed	rpm	R	5078	5079	register
EC fan N°2: maximum allowable speed	rpm	R	5079	5080	register
EC fan N°2: actual power	W	R	5080	5081	register
EC fan N°3: actual speed	rpm	R	5082	5083	register
EC fan N°3: maximum allowable speed	rpm	R	5083	5084	register
EC fan N°3: actual power	W	R	5084	5085	register
EC fan N°4: actual speed	rpm	R	5086	5087	register
EC fan N°4: maximum allowable speed	rpm	R	5087	5088	register
EC fan N°4: actual power	W	R	5088	5089	register
EC fan N°5: actual speed	rpm	R	5090	5091	register
EC fan N°5: maximum allowable speed	rpm	R	5091	5092	register
EC fan N°5: actual power	W	R	5092	5093	register
EC fan N°6: actual speed	rpm	R	5094	5095	register
EC fan N°6: maximum allowable speed	rpm	R	5095	5096	register
EC fan N°6: actual power	W	R	5096	5097	register
EC fan N°7: actual speed	rpm	R	5098	5099	register
EC fan N°7: maximum allowable speed	rpm	R	5099	5100	register
EC fan N°7: actual power	W	R	5100	5101	register
EC fan N°8: actual speed	rpm	R	5102	5105	register
EC fan N°8: maximum allowable speed	rpm	R	5103	5103	register
EC fan N°8: actual power	W	R	5104	5104	register
EC fan N°9: actual speed	rpm	R	5106	5107	register
EC fan N°9: maximum allowable speed	rpm	R	5107	5108	register
EC fan N°9: actual power	W	R	5108	5109	register
EC fan N°10: actual speed	rpm	R	5110	5111	register

Variable	UOM	R/W	Index	Modbus	
				Address	Type
EC fan N°10: maximum allowable speed	rpm	R	5111	5112	register
EC fan N°10: actual power	W	R	5112	5113	register
EC fan N°11: actual speed	rpm	R	5114	5115	register
EC fan N°11: maximum allowable speed	rpm	R	5115	5116	register
EC fan N°11: actual power	W	R	5116	5117	register
EC fan N°12: actual speed	rpm	R	5118	5119	register
EC fan N°12: maximum allowable speed	rpm	R	5119	5120	register
EC fan N°12: actual power	W	R	5120	5121	register
EC fan N°13: actual speed	rpm	R	5122	5123	register
EC fan N°13: maximum allowable speed	rpm	R	5123	5124	register
EC fan N°13: actual power	W	R	5124	5125	register
EC fan N°14: actual speed	rpm	R	5126	5127	register
EC fan N°14: maximum allowable speed	rpm	R	5127	5128	register
EC fan N°14: actual power	W	R	5128	5129	register
EC fan N°15: actual speed	rpm	R	5130	5131	register
EC fan N°15: maximum allowable speed	rpm	R	5131	5132	register
EC fan N°15: actual power	W	R	5132	5133	register
Standard/Free cooling switch over (0: Standard / 1: Free cooling)	---	R/W	1	2	coil
Free cooling status (0: OFF / 1: ON)	---	R	2	3	coil
Night quiet mode (0: Disable / 1: Enable)	---	R/W	4	5	coil
Night quiet mode status (0: not active / 1: active)	---	R	5	6	coil
Run authorization (0: OFF / 1: ON)	---	R/W	9	10	coil
Cleaning cycle (0: Disable / 1: Enable)	---	R/W	10	11	coil
Pre-cooling deactivation function (0: Deactivate / 1: Activate)	---	R/W	11	12	coil
NO1 relay output status - Alarm(s) (0: No alarm / 1: Alarm)	---	R	13	14	coil
NO2 relay output status- Warning(s) (0: No warning / 1: Warning)	---	R	14	15	coil
NO3 relay output status - Make-up valve(0: Closed / 1: Open)	---	R	15	16	coil
NO4 relay output status - Drain valve (0: Closed / 1: Open)	---	R	16	17	coil
NO5 relay output status - Pump (0: Stopped / 1: Running)	---	R	17	18	coil
NO6 relay output status - Run indication (0: Stopped / 1: Running)	---	R	18	19	coil
B3 Dig In status - Flow switch (0: No flow / 1: Flow)	---	R	19	20	coil
B5 Dig In status - Pump override (0: Disabled / 1: Enabled)	---	R	20	21	coil
B6 Dig In status - Free cooling mode (0: Disabled / 1: Enabled)	---	R	21	22	coil
ID1 - Remote start/stop status (0: OFF / 1: ON)	---	R	22	23	coil
ID2 - Float switch position (0: high level / 1: Low level)	---	R	23	24	coil
Alarm flow switch	---	R	26	27	coil
Warning pump	---	R	28	29	coil
Fan N°2 - alarm/warning present	---	R	29	30	coil
Fan N°3 - alarm/warning present	---	R	30	31	coil
Fan N°4 - alarm/warning present	---	R	31	32	coil
Fan N°5 - alarm/warning present	---	R	32	33	coil
Fan N°6 - alarm/warning present	---	R	33	34	coil
Fan N°7 - alarm/warning present	---	R	34	35	coil
Fan N°8 - alarm/warning present	---	R	35	36	coil
Fan N°9 - alarm/warning present	---	R	36	37	coil
Fan N°10 - alarm/warning present	---	R	37	38	coil
Fan N°11 - alarm/warning present	---	R	38	39	coil

Variable	UOM	R/W	Index	Modbus	
				Address	Type
Fan N°12 - alarm/warning present	---	R	39	40	coil
Fan N°13 - alarm/warning present	---	R	40	41	coil
Fan N°14 - alarm/warning present	---	R	41	42	coil
Fan N°15 - alarm/warning present	---	R	42	43	coil
Night quiet mode: clock mode active (0: No / 1: Yes)	---	R	44	56	coil
Night quiet mode: BMS mode active (0: No / 1: Yes)	---	R	45	57	coil
Night quiet mode day/night time speedlimit via BMS (0: night / 1: day)	---	R/W	46	58	coil
Alarm present	---	R	59	60	coil
Unit status (0: OFF / 1: ON)	---	R	63	64	coil
Warning present	---	R	66	67	coil
Alarm sensor B4 (ambient temperature sensor)	---	R	67	68	coil

Commissioning guide Modbus RS485

This guide will show the commissioning procedure to activate the Carel PLC with the Modbus RS485 protocol.

Requirements:

- PC/Laptop
- Carel PLC with Carel RS485 serial card (PCOS004850)
- RS485 to USB converter

Next steps will be executed during this guide:

1. Hardware setup
2. Check the configuration of the Carel PLC

HARDWARE SETUP

Make sure the Carel RS485 serial card (PCOS004850) is installed on the Carel PLC.

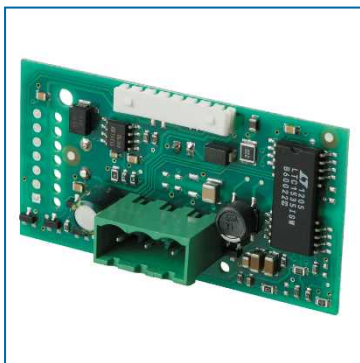

Connect the serial card to your laptop by using the RS485 to USB convertor.



Make sure that the polarity of the wiring between the serial card and the converter is correct. The wiring should be as follows:

- Rx+/Tx+ -> +
- Rx-/Tx- -> -

It might be possible that other convertor suppliers use other terminology. In this case they will probably use the next descriptions.

- A -> +
- B -> -

Do not connect the GND connection when you use the convertor in combination with your laptop. You might get wrong readouts when the GND is connected to your laptop. The GND connection only needs to be used when connecting the serial card with the customer network.

Now power the controller.

CAREL PC05 CONFIGURATION

Make sure the Carel PLC is configured correctly.

- Go to the User (E) menu
- Enter the password "0000"
- Go to the User screen E17
- Define the protocol as Modbus RS485



The controller uses these factory settings:



Baud rate	19200
Address	001
Parity	None
Stop bit	2
Data bits	8

These settings can be adjusted via the control panel.

The Carel PLC and the serial card are now ready to be integrated in the Modbus RS485 protocol installation.



More information

REFERENCE LITERATURE

- Eurovent 9-5 (6) Recommended Code of Practice to keep your Cooling System efficient and safe. Eurovent/Cecomaf, 2002, 30p.
- Guide des Bonnes Pratiques, Legionella et Tours Aéroréfrigérantes. Ministères de l'Emploi et de la Solidarité, Ministère de l'Economie des Finances et de l'Industrie, Ministère de l'Environnement, Juin 2001, 54p.
- Voorkom Legionellose. Ministerie van de Vlaamse Gemeenschap. December 2002, 77p.
- Legionnaires' Disease. The Control of Legionella Bacteria in Water Systems. Health & Safety Commission. 2000, 62p.
- Hygienische Anforderungen an raumluftechnische Anlagen. VDI 6022.

INTERESTING WEBSITES

Baltimore Aircoil Company	www.BaltimoreAircoil.com
BAC Service website	www.BACservice.eu
Eurovent	www.eurovent-certification.com
European Working Group on Legionella Infections (EWGLI)	EWGLI
ASHRAE	www.ashrae.org
Uniclimate	www.uniclimate.fr
Association des Ingénieurs et techniciens en Climatique, Ventilation et Froid	www.aicvf.org
Health and Safety Executive	www.hse.gov.uk

ORIGINAL DOCUMENTATION

 This manual is originally made in English. Translations are provided for your convenience. In the event of discrepancies, the English original text shall prevail over the translation.

The service expert for BAC equipment

We offer tailored services and solution for BAC cooling towers and equipment.

- Original spare parts and fill -for an efficient, safe and year round reliable operation.
- Service solutions - preventive maintenance, repairs, refurbishments, cleaning and disinfection for reliable trouble-free operation.
- Upgrades and new technologies - save up energy and improve maintenance by upgrading your system.
- Water treatment solutions - equipment for controlling corrosion scaling and proliferation of bacteria.

For more details, contact your local BAC representative for further information and specific assistance at www.BACservice.eu



A series of horizontal dotted lines spanning the width of the page, providing a template for handwritten notes or a list.



A series of horizontal dotted lines for writing, spanning the width of the page.



A series of horizontal dotted lines for writing, spanning the width of the page.





A series of horizontal dotted lines for writing, spanning the width of the page.



A series of horizontal dotted lines spanning the width of the page, providing a template for writing or data entry.





A series of horizontal dotted lines for writing, spanning the width of the page.

COOLING TOWERS

CLOSED CIRCUIT COOLING TOWERS

ICE THERMAL STORAGE

EVAPORATIVE CONDENSERS

HYBRID PRODUCTS

PARTS, EQUIPMENTS & SERVICES

BLUE by nature
GREEN at heart



www.BaltimoreAircoil.com

Europe@BaltimoreAircoil.com

Please refer to our website for local contact details.

Industriepark - Zone A, B-2220 Heist-op-den-Berg, Belgium

© Baltimore Aircoil International nv